

## IN THE FIELD

# Characteristics and assessment of the electricity consumption of metro systems: A case study of Tianjin, China

Yanzhe Yu<sup>1,2,3</sup>  | Shijun You<sup>1,3</sup> | Tianzhen Ye<sup>1,3</sup>  | Yaran Wang<sup>1</sup> | Xingguo Guo<sup>2</sup> | Wenhua Chen<sup>2</sup> | Tianqi Liu<sup>4</sup> | Shen Wei<sup>5</sup> | Yanling Na<sup>3,6</sup>

<sup>1</sup>School of Environmental Science and Engineering, Tianjin University, Tianjin, China

<sup>2</sup>School of Infrastructure Engineering, Nanchang University, Nanchang, China

<sup>3</sup>National Engineering Research Center for Digital Construction and Evaluation of Urban Rail Transit, Tianjin, China

<sup>4</sup>School of Architecture, Carnegie Mellon University, Pittsburgh, Pennsylvania, USA

<sup>5</sup>The Bartlett School of Sustainable Construction, University College London (UCL), London, UK

<sup>6</sup>China Railway Design Corporation, Tianjin, China

### Correspondence

Tianzhen Ye, School of Environmental Science and Engineering, Tianjin University, Tianjin 300350, China.  
Email: [tzhye@tju.edu.cn](mailto:tzhye@tju.edu.cn)

### Funding information

Tianjin Science and Technology Plan Project, Grant/Award Number: 18ZXGDGX00080

### Abstract

Owing to the complexity of metros, the energy consumption characteristics of metro systems exhibit variability and the energy-saving management of the systems encounters challenges. To encapsulate the essential characteristics of energy usage and to objectively assess the energy performance of metro systems, this study presents a generalized framework and applies it to a case study conducted in Tianjin. The study also employs correlation analysis to investigate the applicability of the indicators relevant to ridership. The results indicate that the monthly traction electricity consumption exhibits slight variation, while station electricity usage demonstrates substantial fluctuation with seasonal changes. For Tianjin Metro, the passenger factor hardly shows any effect on the electricity use of metro lines. The median value of traction electricity use is approximately 2.0 kWh/(car-km) and that of the average annual station electricity use of underground lines ranges from 95 to 155 kWh/m<sup>2</sup>. The emission from the traction sector is 12.2 kgCO<sub>2</sub>/(vehicle-km) and from the station sector is 118.6 kgCO<sub>2</sub>/m<sup>2</sup>. The study also identifies the energy-intensive lines of the Tianjin Metro and compares the energy utilization among various global metro systems. The authors hope that this study can help shed light on the assessment of the energy status of metro systems and serve as a source of information for other City-Metros to implement energy-saving management.

### KEYWORDS

assessment, carbon emissions, electricity consumption, metro systems, statistical analysis

This is an open access article under the terms of the Creative Commons Attribution License, which permits use, distribution and reproduction in any medium, provided the original work is properly cited.

© 2023 The Authors. *Energy Science & Engineering* published by Society of Chemical Industry and John Wiley & Sons Ltd.

## 1 | INTRODUCTION

### 1.1 | Backgrounds

By the end of 2020, metros were available in 193 cities all over the world, responsible for delivering a total of 190 million passengers per day.<sup>1</sup> Especially for China, with a track length of 6280.8 km and a total of 4681 stations nationwide in 2020.<sup>2</sup> However, the energy consumption of metros has enormously increased with the development of metros.<sup>3,4</sup> For example, metro systems were reported to consume 11.1 billion kWh of electricity in China in 2016.<sup>5</sup> Therefore, energy savings in metro systems are urgently needed in this era of energy shortage.<sup>6,7</sup> The energy consumption of metro systems is influenced by a variety of components, such as vehicles, stations, and other infrastructures.<sup>8,9</sup> To minimize the system's energy consumption, it is crucial to acquire a thorough understanding of the characteristics of energy utilization of components and employ a rigorous evaluation approach to evaluate the energy condition.

### 1.2 | Pioneer works

As for metro systems, studies paid attention to the energy structure and characteristics of the system.<sup>10–12</sup> The energy use in metros is generally classified into traction and nontraction purposes. The former refers to the energy required to operate the rolling stock and includes propulsion and on-board auxiliary systems. The latter considers the energy consumed at stations, depots, and other infrastructure-related facilities.<sup>13</sup> Figure 1 shows a typical power supply network of metro systems. Most

metros use direct current (DC) to power the rolling stock, generally at 600, 750, or 1500 V. Nontraction loads are supplied through specific transformers conditioning the power from the distribution system. Such transformers are independent of traction substations and use alternating current (AC) to power stations, generally at 380/400 V.

Generally, between 50% and 70% of the energy use in metros is attributable to traction requirements.<sup>13,14</sup> To reduce the use of traction energy, many energy-saving technologies were developed, such as regenerative braking,<sup>15,16</sup> energy storage system,<sup>17</sup> energy-efficient driving,<sup>18</sup> multiobjective optimization of the transportation organization,<sup>19</sup> and so forth. Energy-efficient design strategies, such as train mass reduction, improved air aerodynamics and friction, increasing maximum traction and braking force, as well as the efficient design of gradients contribute significantly to rolling stock energy saving.<sup>20</sup>

On the other hand, the nontraction electricity consumption, primarily consumed by metro stations was investigated by on-site surveys. Guan et al. conducted a statistical analysis of the electricity consumption of metro stations in China and found that the annual electricity consumption of underground stations was about 131–144 kWh/m.<sup>21</sup> Furthermore, Guan et al. also monitored the hourly energy consumption of metro systems and revealed that the hourly electricity consumption of train traction shows an intraday “U” shape on weekdays, indicating two symmetric peaks in the rush hours, while the station hourly electricity consumption shows an intraday “flat” shape, indicating it is nearly free from the effect of rush hour.<sup>12</sup> Lin et al. indicated that the electricity consumption of ventilation and air-conditioning (VAC) and lighting systems in metro

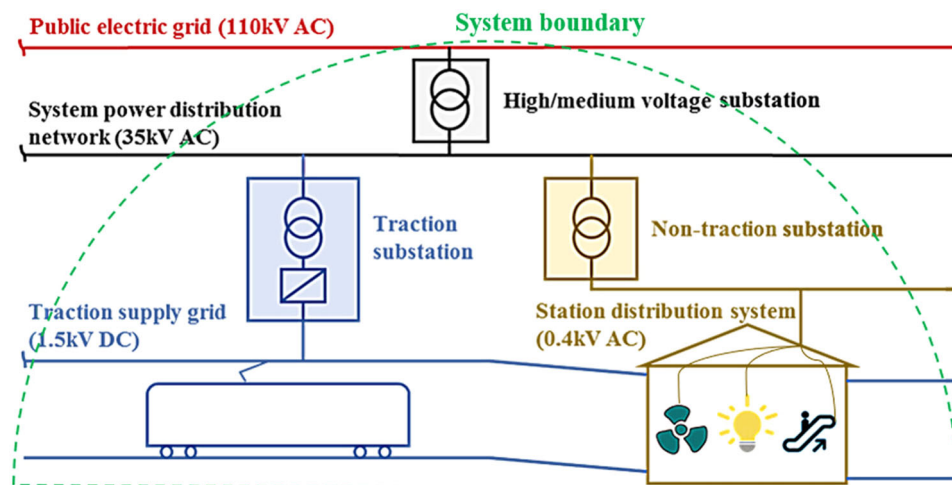

FIGURE 1 Schematic of a typical power supply network in metros. Adapted from Powell et al.<sup>14</sup> AC, alternating current; DC, direct current.

stations can account for 55%–70% of the total station electricity use, and the building area as an important parameter affecting the energy consumption should be used as the basis for energy evaluation.<sup>22</sup> Due to the limited measured data, Ahn et al. established a statistical analysis model by combining the simulation data to benchmark the energy use intensity of metro stations in Seoul, South Korea.<sup>23</sup>

Studies relevant to the energy use of metro stations or lines are rare because of a lack of detailed energy metering and historical data.<sup>24,25</sup> In addition, the study of metro energy is challenging since the nontraction energy use is affected by various factors. For traction energy use, its value is mainly affected by train type and travel distance.<sup>26</sup> For station energy use, there are many factors.<sup>12,27</sup> First, the variable outdoor climate influences the energy consumption of the VAC system.<sup>28,29</sup> Second, the floor area determines the setting of lighting and other facilities.<sup>30</sup> Third, ridership can affect the energy consumption of ventilation fans and escalators and lifts (elevators) when these devices are running at variable frequencies.

To evaluate the metro energy status from different perspectives, a series of indicators were proposed. Primary energy performance indicators for metro systems are summarized in Table 1. These energy indicators can be divided into three categories according to evaluation purposes, namely, traction energy use, station electricity use, and comprehensive carbon emissions.<sup>44</sup> The most used indicators are based on the unit “area” and “passenger.” The applicability of the indicator based on the unit “area” has been well justified for nontraction energy evaluation, while the indicators relating “passenger” remain to be discussed due to various conditions.<sup>21,22</sup> Specifically, whether the passenger factor should be considered in the nontraction energy evaluation when fixed-frequency devices are used or the

equipment affected by the passenger is in a fixed-frequency operation mode is still a question.

### 1.3 | Purpose of the paper

Although studies have investigated metro energy consumption, the existing research is insufficient to develop an energy evaluation system that summarizes the characteristics of historical metro energy consumption and to clarify the applicability of indicators. The focus should not only be on calculating individual indicators but also require a systematic evaluation process to capture metro energy use characteristics and assess its energy status. Therefore, this study aims to establish a generalized evaluation framework that captures essential energy features and evaluates the energy status of metro systems. The applicability of ridership-related indicators is also explored in the case that the existing stations with their devices operate in a fixed frequency mode. A typical metro system located in the North China Plain is used as a case study, and relevant data are collected from 2013 to 2019. The remainder of the paper is organized as follows: Section 2 introduces the analysis methods and materials; Section 3 presents a case study conducted on the Tianjin Metro using the framework; Section 4 presents a thorough conclusion of the paper. The objective of this study is to provide a reference for stakeholders involved in improving City-Metro's competitiveness by reducing its operational energy.

## 2 | METHODS AND MATERIALS

The methods of this study are as follows: (1) review the pioneer studies on energy use and assessment in metro systems to aggregate an indicator set (see Table 1); (2)

**TABLE 1** Primary energy performance indicators for metro systems.

Category	Indicator	References
Traction energy use	Yearly electricity consumption per passenger	[27, 31, 32]
	Yearly electricity consumption per car-km	[27, 33–35]
	Yearly electricity consumption per passenger-km	[19, 33, 36]
Station energy use	Yearly electricity consumption per passenger	[24, 27, 37]
	Yearly electricity consumption per square meter	[21–23, 38–41]
	Yearly electricity consumption per passenger-km	[19]
Comprehensive carbon emissions	Yearly amount of CO <sub>2</sub> emissions per passenger	[42]
	Yearly amount of CO <sub>2</sub> equivalent emissions per square meter	[43]
	Yearly amount of CO <sub>2</sub> equivalent emissions per passenger-km	[31, 32, 44, 45]

develop a generalized energy assessment framework for the metro system of the operation phase; (3) apply the framework to the Tianjin Metro energy assessment as a case study.

## 2.1 | A general framework

A generalized framework was developed to provide insights into long-term energy assessment in metro systems, as presented in Figure 2. The framework consists of five sections, namely, determine the scope of the assessment, collect and analyze historical energy use, study the metro system and its operational characteristics, evaluate the energy status of the metro system, and report results.

First, the scope of the assessment needs to be determined, which includes the boundary of the energy-using system, the evaluation period, the type of fuel and specific equipment, and so forth. Second, important information should be collected, like information about energy, lines, stations, ridership, and so forth. Then, the data need to be processed, including data cleaning and disaggregation. For example, existing metro generally records total energy data and traction energy data, and station energy data can be obtained by

subtracting the traction energy from the total energy. The energy data of the air conditioning system can be obtained by subtracting the station energy data during the transition season from the data during the cooling season. Data can be observed and analyzed from different perspectives to understand the characteristics of energy use, such as time series and items of energy use. The third step is to study the metro system and its operational characteristics through surveys. The fourth step is to aggregate and determine the appropriate evaluation indicators using correlation analysis according to evaluation purposes. Here, the aggregated indicator set is shown in Table 1. The metro energy performance then can be horizontally benchmarked using end-use metrics (such as energy data normalized by floor area or ridership) or point-based (such as predefined best-practice standards); and vertically benchmarked. Finally, the assessment results should be reported to describe the energy features and status of the metro system, as well as clarify the energy-saving direction of the system.

## 2.2 | Data collection

The study data were collected from the metro networks in Tianjin, a municipality in northern China. The Tianjin

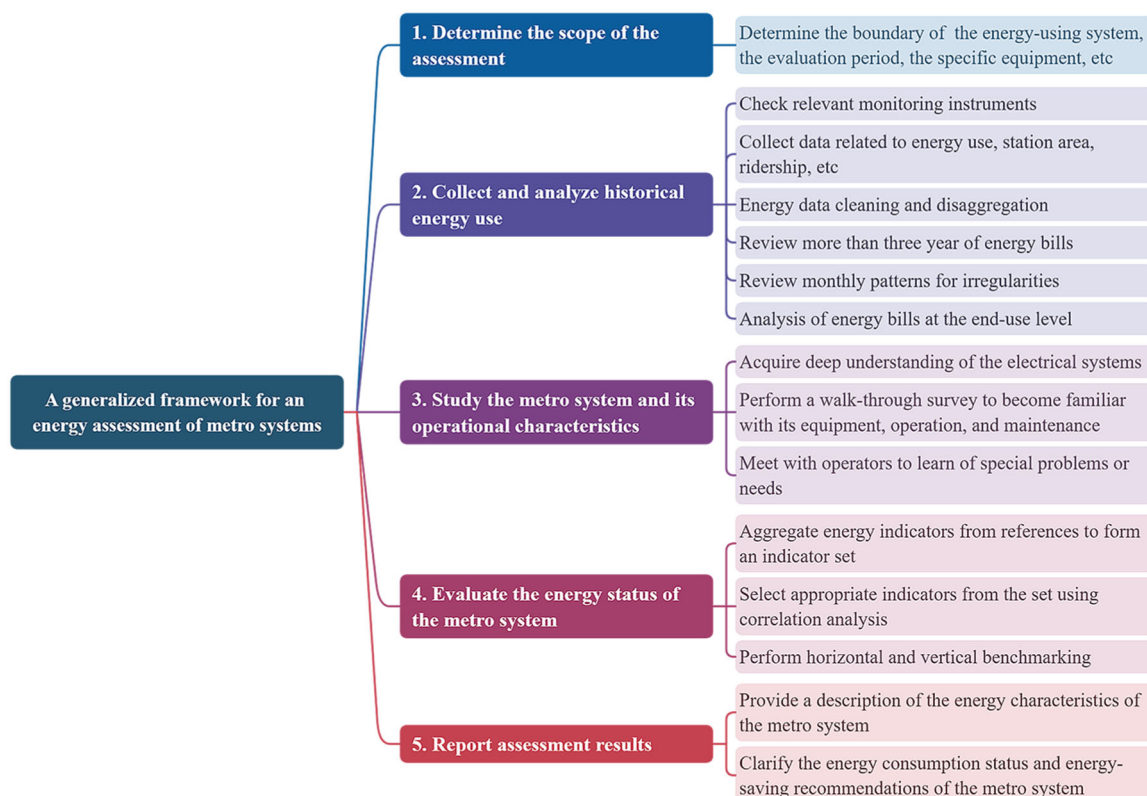
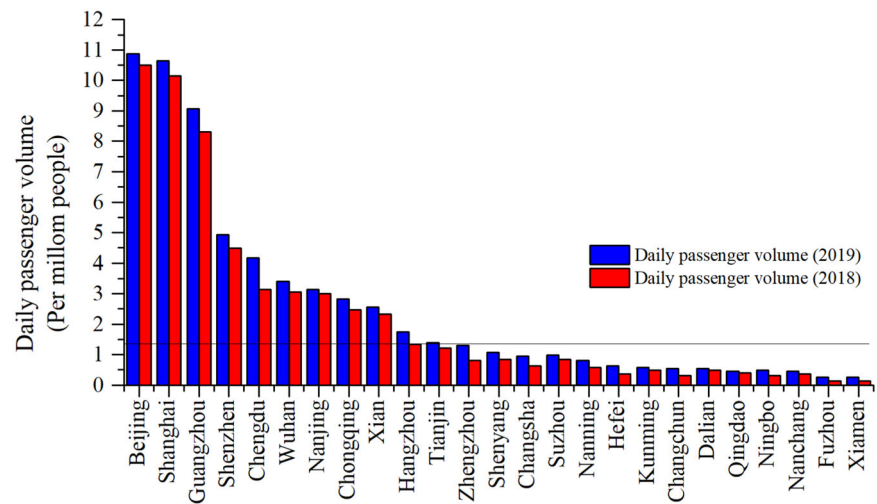

FIGURE 2 A generalized framework for an energy assessment of metro systems.

**FIGURE 3** Average daily passenger volume of metros in Chinese cities in 2018 and 2019.



Metro started operating in 1984 and now has six lines. Among cities in northern China, the Tianjin Metro is second only to the Beijing Metro in terms of size and energy consumption. By the end of 2019, the passenger traffic volume of the Tianjin Metro System is <1.5 million people per day and ranks 11th in China, as shown in Figure 3. Therefore, the Tianjin Metro has a certain representativeness in cities with medium-level passenger flow.<sup>6,46</sup>

There are six lines and 154 stations in Tianjin. The opening time, length, and number of stations for each line are shown in Table 2. Line 1 was the first to be built, line 9 was the longest, line 6 has the most stations, and all but line 9 are underground lines. Lines 2 and 6 are selected for the following correlation analysis because they share similar characteristics, such as the number of underground stations >95%, and the operating trains consisting of type 6 coaches of B-type cars. Their station's VAC equipment is operated at a fixed frequency and manually managed based on the same schedule.

Since electricity is the main form of energy consumed in metro systems, this study mainly evaluates the energy performance based on the electricity data and nontraction electricity use is referred to as station electricity use according to the collected data. The collected data mainly includes monthly traction electricity consumption (MTEC) and station electricity consumption, passenger flow, and subitem electricity consumption of two stations. The monthly station electricity consumption (MSEC) refers to the sum of electricity of all stations on that line. The relevant electricity data of the metro system was collected from the metro management's monitoring platform recorded between 2013 and 2019 and thoroughly investigated among the vast information. The items of the data are divided into four categories: general things, buildings, services, and energy consumption amounts. Details are shown in Table 3.

**TABLE 2** General data of metro networks in Tianjin.

Lines	1	2	3	5	6	9
Opening time	1984	2012	2012	2018	2016	2004
Length (km)	26.2	27.1	33.8	35	47	52.8
Number of stations	22	20	26	27	38	21
Underground stations	13	19	18	26	37	5
Nontransfer stations	18	16	21	19	30	19
Island platform stations	4	18	18	21	32	6

**TABLE 3** Items of the data.

Subject	Items
General	Condition of metro lines (see Table 1), monthly passenger volume
Stations	Year of construction, structure, area
Services	VAC and other facilities
Energy consumption	Monthly traction/station electricity consumption

Abbreviation: VAC, ventilation and air-conditioning.

## 2.3 | Analysis method

The energy data were processed by data cleaning and disaggregation before the analysis as described in Section 2.1. To screen the unusual data, the interquartile range of the data was calculated.<sup>47</sup> This study evaluated the influence of ridership factors on electricity consumption using Spearman's correlation coefficient ( $\rho$ ). Spearman's correlation coefficient is suitable for judging whether two random variables have a covariant trend in two-dimensional and multidimensional space. It can

overcome the shortcoming that Pearson's correlation coefficient is only suitable for describing linear correlation, and it provides that the degree of covariation trend under the correlation of two random variables is linearly correlated or nonlinear; meanwhile, for the situation of unclear overall distribution and lack of general information, Spearman's correlation analysis can obtain reliable conclusions. The  $\rho$  is calculated as follows<sup>48</sup>:

$$\rho = 1 - \frac{6 \sum_{i=1}^n d_i^2}{n(n^2 - 1)}, \quad (1)$$

where  $d_i = X_i - Y_i$  is the difference between the ranks of variables  $X$  and  $Y$  for the  $i$ th observation and  $n$  is the number of samples. The value of  $\rho$  ranges from  $-1$  to  $+1$ . Positive/negative signs indicate positive/negative correlations between variables.

For the carbon emission analysis of metro systems, the carbon emissions are calculated based on the amount of electricity consumed, and the CO<sub>2</sub> production is mainly concentrated in coal power generation. Therefore, the study mainly considers the CO<sub>2</sub> produced in power generation with coal as the source, specifically see

Equation (2).<sup>6</sup>  $E_c$  is the CO<sub>2</sub> emission of metro systems,  $D$  is the electricity consumption of metro systems,  $P$  is the proportion of coal power, and  $C$  is the CO<sub>2</sub> emission factor of coal power generation. In this study,  $P$  is 100% and  $C$  is 0.9419 (tCO<sub>2</sub>/MWh)<sup>49</sup>

$$E_c = D \times P \times C. \quad (2)$$

### 3 | RESULTS AND DISCUSSION

#### 3.1 | Characteristics of metro electricity consumption

##### 3.1.1 | Analysis of electricity consumption patterns over time

To analyze the characteristics of electricity consumption, the electricity data of the Tianjin Metro were compared from different perspectives. The trend in annual total electricity consumption of metro lines over the years is presented in Figure 4A. The trend of the annual total

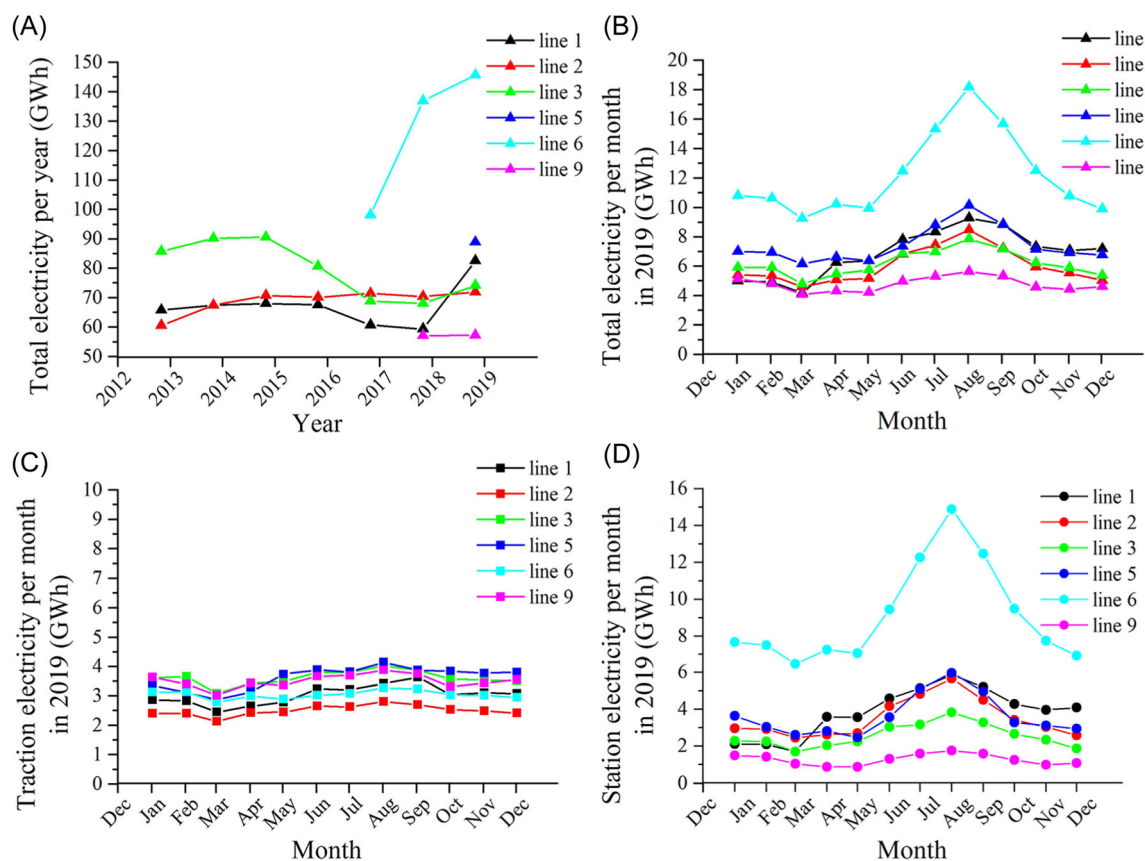

FIGURE 4 Comparison of electricity consumption between different metro lines: (A) Yearly total electricity consumption, (B) monthly total electricity consumption, (C) monthly traction electricity consumption, and (D) monthly station electricity consumption.

electricity consumption of line 1, line 2, and line 3 was similar and the value fluctuates between 60 and 90 GWh. Among them, the trend of electricity consumption of line 2 was relatively flat and that of line 1 and line 3 has changed with time because of the later extension project and the implementation of electricity saving management.

Figure 4B shows the monthly total electricity consumption of lines in 1 year (2019); the monthly total electricity consumption of most lines ranged from 4 to 8 GWh, expected for line 6. Line 6 has a significantly higher energy consumption than the other lines, which can be attributed to its largest number of stations. Additionally, the total monthly electricity consumption of these lines has increased significantly in summer due to the use of VAC systems.

The electricity consumption of stations was found to be the same magnitude as that of traction and even greater in some cases as shown in Figure 4C,D. The MSEC of lines was between 1 and 4 GWh, and it fluctuates greatly with seasonal change. The monthly electricity consumption of line 6 was the highest and that of line 9 the lowest. As the number of stations of line 9 was more than that of line 2, but the MSEC of line 9 was lower than that of line 2, it is indicated that elevated stations consume less electricity than underground stations. One possible explanation is that elevated stations can use natural lighting and ventilation to reduce equipment electricity consumption.

From Figure 4A,B, it can be concluded that the total electricity consumption of underground lines was higher than that of the elevated line. From Figure 4B–D, it can be concluded that the trend of MTEC of all lines was smooth and the values of different lines were close to each other; the station electricity consumption

of underground lines fluctuates greatly with seasonal changes.

### 3.1.2 | Comparison of electricity consumption between subentries

To better understand the electricity consumption characteristics of metro lines, the time series of subentry electricity consumption in one line was also investigated. Since metro line 2 is an underground line and has not been modified or expanded during operation, its data on electricity use are more representative than other lines. Therefore, the characteristics of electricity use in line 2 were taken as an example to analyze. The time series of monthly electricity consumption of line 2 was presented in Figure 5, the electricity use of the traction sector was kept flat, and the station sector changed with the season and almost reached a peak each August.

Figure 6 shows the historical data for the monthly station electricity use of line 2 and the monthly station electricity use pattern. The annual trend of historical data of MSEC is similar and changes according to season (see Figure 6A). Thus, the monthly yearly total electricity use of the station can be disaggregated into basic electricity use ( $E_b$ ) and variable electricity use ( $E_v$ ), as shown in Figure 6B. The former was a relatively stable itemized energy consumption, which does not change significantly with external factors and was mainly related to the function of the station building. The latter change is closely related to the climate and was mainly used to meet the requirements of the indoor environment of the stations during outdoor climate change. The  $E_b$  and  $E_v$  can be written as

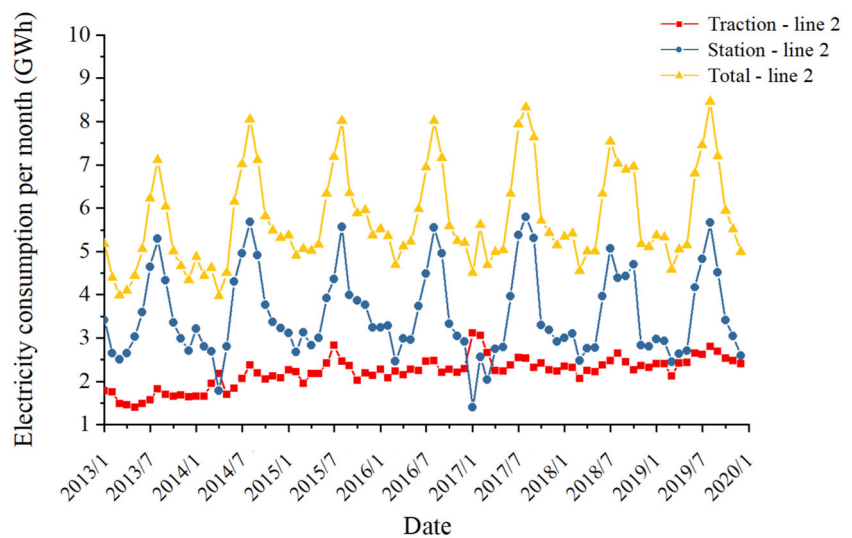

FIGURE 5 Time series of monthly electricity consumption of line 2.

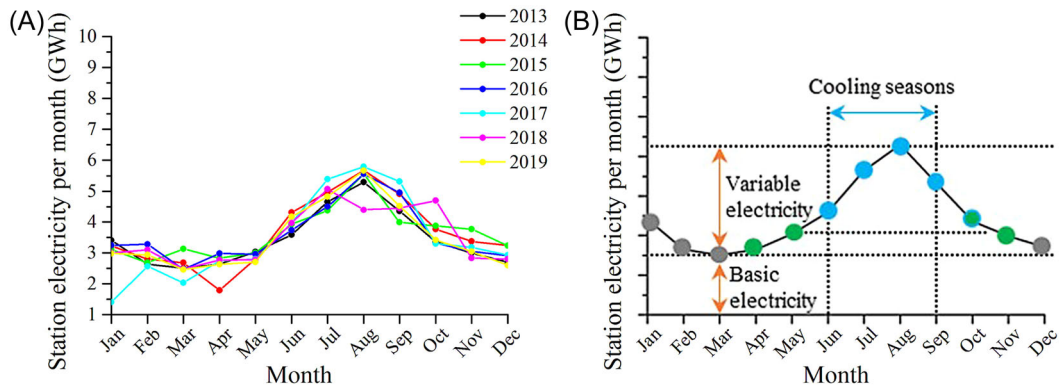

FIGURE 6 (A) Historical data of monthly station electricity use on line 2 and (B) monthly station electricity use pattern (illustrative view).

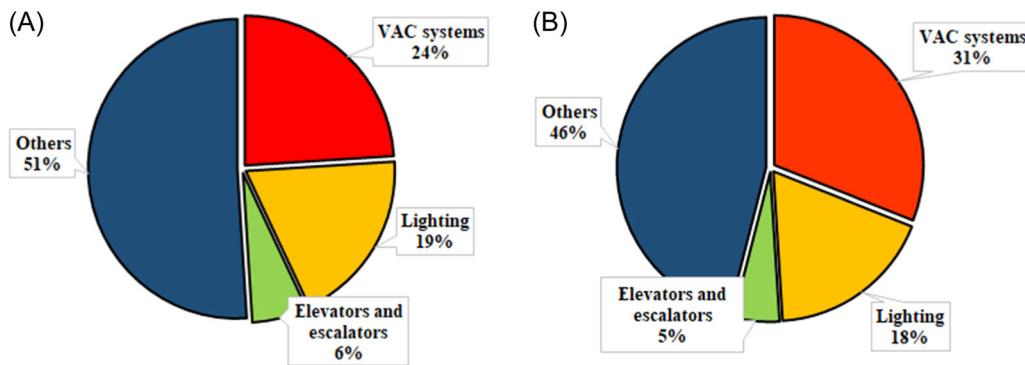

FIGURE 7 Proportions of electricity consumption by different subentries in underground stations in June 2016: (A) Station A and (B) Station B. VAC, ventilation and air-conditioning.

$$E_b = 365e_b, \quad (3)$$

$$E_v = E_s - E_b, \quad (4)$$

where  $e_b$  is the lowest daily electricity consumption throughout the year and  $E_s$  is the yearly total electricity consumption of the station.

According to on-site surveys, the monthly electricity consumption proportion of each subsystem of two typical underground stations with the same floor area in Tianjin is shown in Figure 7. The VAC system was responsible for 24% of the total electricity consumption of station A, as shown in Figure 7A. Lighting was responsible for 19% of total consumption, whereas vertical transportation accounted for another 6%. At station B, the VAC system was responsible for 31% of total electricity consumption, as shown in Figure 7B. Lighting accounted for 18% of total electricity consumption, and vertical transportation accounted for approximately 5% of the total. The proportions of electricity consumption of lighting and vertical transportation were similar in the two stations, but that of the VAC systems showed differences.

### 3.2 | Correlation analysis on the passenger factor

To perform a reliable assessment, the indicator related to the passenger factor was discussed using correlation analysis. Spearman's correlation coefficient shows the potential correlation between different variations (see Table 4), namely, MTEC, MSEC, monthly passenger volume (MPV), and monthly passenger kilometer traveled (MPKT). It is interesting to discover that there was a negative correlation between MTEC and MPV, as well as MSEC and MPV in lines 2 and 6 when their data were analyzed together, as these lines show similar features. The result shows that there was no relationship between MTEC and MPKT, as well as between MSEC and MPKT. To further determine the relationship between different variations, the data from each line were analyzed and shown in Table 4. There was almost no correlation in most cases.

Furthermore, to explain the negative correlation exhibited in lines 2 and 6, the specific value of variables (2018–2019) was presented in Figure 8. There was no



negative correlation between the variables of electricity use and passenger volume in either line, and the MPV of line 2 was higher than that of line 6, but both MTEC (Figure 8A) and MSEC (Figure 8B) of line 2 were lower than that of line 6. Therefore, the negative correlation occurred because the data were mixed proceed. This phenomenon also shows the irrelevance between passenger flow and the electricity consumption of metro lines, although the lines share the same design features.

It is possible that this phenomenon is because the main energy-consuming facilities of the metro station are less affected by the flow of passengers. However, it is generally believed that the energy consumption of the VAC system is greatly affected by passenger volume. In fact, the supply of fresh air is not linearly adjusted according to the passenger volume but operates in a conventional fixed frequency mode. If the impact of fresh air is not considered, the impact of passenger volume is mainly through the heat dissipation of the human body

TABLE 4 Spearman's correlation analysis results.

Line	Variables ( $\rho$ value)			
	MTEC and MPV	MTEC and MPKT	MSEC and MPV	MSEC and MPKT
2 and 6	-0.418**	0.104	-0.496**	0.193
1	0.318	0.370*	-0.074	-0.136
2	0.279	-0.055	0.047	0.119
3	0.152	0.311	-0.063	0.029
6	0.192	0.129	0.258	0.340
9	0.331*	-0.004	-0.269	0.003

Abbreviations: MPKT, monthly passenger kilometer traveled; MPV, monthly passenger volume; MSEC, monthly station electricity consumption; MTEC, monthly traction electricity consumption.

\*\*Correlation was signification at the 0.05 level (two-tailed).

\*Correlation was signification at the 0.01 level (two-tailed).

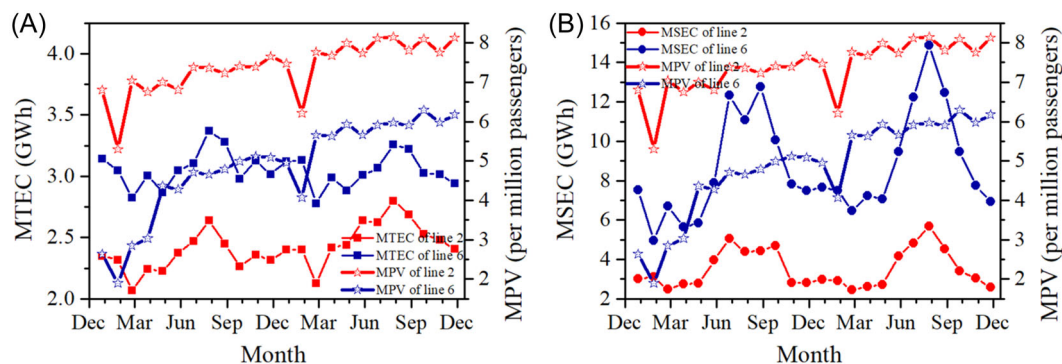

FIGURE 8 Trend of research variables of lines 2 and 6: (A) monthly traction electricity consumption (MTEC) and monthly passenger volume (MPV) and (B) monthly station electricity consumption (MSEC) and MPV.

to affect the air-conditioning load, which is extremely limited in metro systems with low passenger volume. Therefore, in the follow-up research of this paper, the energy consumption per unit of building area was used as the unit for station energy evaluation.

### 3.3 | Evaluation of metro electricity use

Based on the analysis presented above, this study calculated two key indicators based on variables (per car-km and  $m^2 a$ ) to reflect the energy use intensity of Tianjin Metro, as shown in Figure 9. In addition, since the data analyzed in the study is the monthly electricity consumption data of the subway system, the amount of data for each line in Figure 9 is 84 (line 1), 84 (line 2), 84 (line 3), 12 (line 5), 36 (line 6), and 12 (line 9). Data for lines 1, 2, and 3 are between 2013 and 2019. Data for lines 5 and 6 are from the year of their opening to 2019. It is important to note that the available data for line 9 is from 2018 to 2019 because its operating company has changed.

Figure 9A shows a boxplot of traction electricity consumption per month of different metro lines. The range of values of traction electricity use of most lines was small, except line 1, which operated since 1984 and had experienced several adjustments of vehicles. Looking at the median value of the traction electricity consumption, it was observed that line 5 has the highest electricity consumption, followed by line 1 and line 9. Line 6 has the lowest electricity consumption. The median value of the traction electricity consumption of most lines was approximately 2.0 kWh/(car-km).

Figure 9B shows a boxplot of the electricity consumption of the stations per month of different metro lines. The range of values of station electricity use of most lines was small, except for lines 1 and 3. The median value of the average annual station electricity consumption of underground lines ranged from 95 to 155 kWh/ $m^2$  and

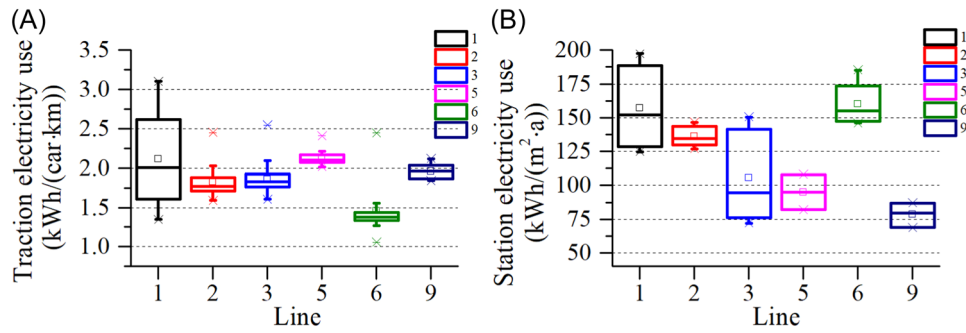

FIGURE 9 Traction and station electricity use boxplots of different lines: (A) Traction electricity use and (B) Station electricity use.

TABLE 5 Comparison of electricity consumption of the metro station in different cities worldwide.

Country	City	Year	Average area of stations ( $\times 10^4 \text{ m}^2$ )	Proportion of underground stations	Average annual passengers (million)	Annual electricity consumption ( $\text{kWh}/\text{m}^2$ )	References
South Korea	Inchon	2001	0.99	95%	3.10	138.06	[39]
	Daegu	2001	0.69	100%	1.69	163.06	
	Busan	2001	0.84	85%	3.73	151.11	
Spain	Barcelona	2012	0.28	100%	5.27	217.64	[24]
Greece	Athens	2020	0.67	100%	1.27	108.13	[20]
China	A	2015	1.64	100%	11.1	136	[21]
	B	2015	0.97	49%	6.2	127	
	C	2016	1.41	71%	2.0	134	
	D	2015	1.32	80%	10.0	136	
	E	2015	1.77	100%	6.0	140	
	Tianjin	2019	1.41	77%	3.4	125.9 (underground stations)	

that of line 6 was the highest, while  $80 \text{ kWh}/\text{m}^2$  in elevated stations of line 9. This sector of electricity use can be greatly affected by climate and management. For example, line 3 has implemented energy-saving management since 2017 and the main measures include switching to light-emitting diode (LED) lighting, reducing the operating time of service equipment, cleaning the VAC system, and so forth. Thus, the median value of the station's electricity consumption was lower than that of other underground lines. In other words, other lines have the potential for energy conservation.

Based on the evaluation results, the overall level of traction electricity consumption of line 5 was the highest and the overall level of station electricity consumption of line 6 was the highest, which indicated the direction for energy-saving work in Tianjin Metro. Furthermore, the on-site investigation showed that the regenerative braking energy system of line 5 is out of order, which led to its high traction power consumption. Line 6 consumes the most station electricity due to its most

significant number of stations, many of which are transfer stations. Therefore, the corresponding energy-saving suggestions for Tianjin Metro are to service the regenerative braking energy system of line 5 and implement energy efficiency management at stations on line 6, such as using LED lighting, properly planning the device running time, cleaning the VAC system, and so forth.

To broaden the significance of this study, a comparative analysis of the energy use of different metro systems around the world was provided. Table 5 compares the electricity consumption of metro stations in different cities around the world. The overall level of City-Metro electricity consumption was between  $116$  and  $217 \text{ kWh}/(\text{m}^2 \text{ a})$  and the electricity consumption of the Tianjin underground stations was the lowest among cities in China, at  $125.9 \text{ kWh}/(\text{m}^2 \text{ a})$ . This can be attributed to Tianjin Metro's energy-saving renovation of the old stations and the adoption of efficient equipment at the new stations, such as LED lighting, high-performance air

**TABLE 6** Comparison of metro traction emissions of different cities.

Country	City	Year	Traction carbon emissions kgCO <sub>2</sub> /(VKT)	References
USA	California	2011	11.9	[50]
Italy	Rome	2013	8.8	[35]
India	Delhi	2012	10.3	[51]
China	Shanghai	2012	11.4	[32]
	Tianjin	2019	12.2	-

conditioning systems, and energy management systems. All these measures are also recommended for the energy conservation of metro stations in other cities.

As for the carbon emissions from electricity consumption of metro systems in Tianjin, the results were also standardized per vehicle-km traveled (VKT, one vehicle has six cars in Tianjin Metro) for the traction sector and per (m<sup>2</sup> annual) for the station sector, respectively. Based on the total rail distance in the Tianjin Metro network, it was 108.4 million car-km; thus, the traction emissions can be converted to 12.2 kgCO<sub>2</sub>/VKT. This value was also compared with other cities around the world, as shown in Table 6.

As shown in Table 6, the traction emission per VKT of Tianjin was found to be the highest among these cities. In terms of station emission intensity, the average annual station emission from Tianjin Metro was 118.6 kgCO<sub>2</sub>/m<sup>2</sup> a). The traction emission intensity of the Tianjin Metro was slightly higher than that of other cities, while the station emission intensity was relatively low. As mentioned previously, traction emissions are affected by train characteristics, the condition of track lines, operating modes, and so forth; station emissions are affected by building features, energy-using systems, device operating modes, outdoor climate, and so forth. However, because such contributing factors are not the focus of this study, a detailed analysis is not provided here.

## 4 | CONCLUSIONS

Currently, there is a strong demand for an energy-efficient metro system as the city's sustainable development and carbon-neutral requirement. Therefore, this paper presented a generalized framework to evaluate the energy performance of metro systems, and the framework was applied to a case study in Tianjin, China. The energy evaluation delivered a detailed analysis of the electricity consumption characteristics and current status

of the Tianjin Metro. The main conclusions were drawn as follows:

1. Metro electricity use characteristics can be summarized as follows: monthly traction electricity consumption exhibited slight variation, while station electricity usage demonstrated substantial fluctuation with seasonal changes. Traction and station electricity usage were similar in magnitude, with underground stations recording higher usage. The annual trend of station electricity consumption was consistent, with usage divisible into basic and variable electricity components for further energy benchmarking. VAC systems, which significantly contributed to variable electricity use, accounted for 24%–31% of the total electricity consumption in Tianjin's underground stations. Furthermore, underground stations have higher annual electricity consumption than elevated stations.
2. In Tianjin, the passenger volume appeared to have a negligible impact on the electricity consumption of metro lines, according to correlation analysis, affecting neither traction nor station electricity consumption. This observation may be attributable to the fixed device operation mode utilized in the metro system. Consequently, indicators relevant to ridership should be chosen judiciously for a similar case.
3. Evaluation results revealed that the median value of the traction electricity consumption of most lines was approximately 2.0 kWh/(car-km), and the median value of the average annual station electricity consumption of the underground lines ranged from 95 to 155 kWh/m<sup>2</sup>, while 80 kWh/m<sup>2</sup> at elevated stations of line 9. The emission from the traction sector was 12.2 kgCO<sub>2</sub>/VKT and 118.6 kgCO<sub>2</sub>/m<sup>2</sup> from the station sector. Line 5 exhibited the highest overall level of traction electricity consumption, and line 6 had the highest overall station electricity consumption, which points to potential areas for energy-saving efforts in the Tianjin Metro.

This study offers insights into the electricity usage characteristics and current status of the Tianjin Metro, identifies the most energy-intensive lines, and provides a direction for energy-saving measures for metro infrastructure managers. We hope that this study will serve as a reference for other cities striving to develop energy-efficient metro systems. Future studies should explore more diverse data sets from various cases, given the diversity of metro systems.

## ACKNOWLEDGMENTS

This work was supported by the Tianjin Science and Technology Plan Project (18ZXGDGX00080). The

authors would like to thank the officials in Tianjin Metro Group Co. Ltd for their cooperation and for providing valuable data in this study.

## CONFLICT OF INTEREST STATEMENT

The authors declare no conflict of interest.

## ORCID

Yanzhe Yu  <http://orcid.org/0000-0003-4868-3632>

Tianzhen Ye  <http://orcid.org/0000-0001-5879-0170>

## REFERENCES

- UITP. *World Metro Figures 2021*. UITP; 2022:1-8.
- China Association of Metros. *Annual Statistics and Analysis of Urban Railway System in 2020*. China Association of Metros; 2021.
- Yu M, Yu R, Tang Y, Liu Z. Empirical study on the impact of China's metro services on urban transportation energy consumption. *Res Transp Econ*. 2020;80(May 2019):100821. doi:10.1016/j.retrec.2020.100821
- Lin D, Broere W, Cui J. Metro systems and urban development: impacts and implications. *Tunn Undergr Space Technol*. 2022;125(March):104509. doi:10.1016/j.tust.2022.104509
- China Association of Metros. *Annual Statistics and Analysis of Urban Railway System in 2016*. China Association of Metro; 2017.
- Zhang L, Long R, Chen H. Carbon emission reduction potential of urban rail transit in China based on electricity consumption structure. *Resour Conserv Recy*. 2019;142(June 2018):113-121. doi:10.1016/j.resconrec.2018.11.019
- Du H, Li Q, Liu X, Peng B, Southworth F. Costs and potentials of reducing CO<sub>2</sub> emissions in China's transport sector: findings from an energy system analysis. *Energy*. 2021; 234:121163. doi:10.1016/j.energy.2021.121163
- Aneesh NR, Shivaprasad KN, Das BB. Life cycle energy analysis of a metro station building envelope through computer based simulation. *Sustain Cities Soc*. 2018;39: 135-143. doi:10.1016/j.scs.2018.02.006
- Gomes FM, Aguiar AO, Vils L. The influence of trains control system modernization on the energy consumption in the Sao Paulo subway. *Energy Sustain Dev*. 2018;47:1-8. doi:10.1016/j.esd.2018.08.001
- Liu M, Jia S, Li P, Liu X, Zhang Y. Predicting GHG emissions from subway lines in the planning stage on a city level. *J Clean Prod*. 2020;259:120823. doi:10.1016/j.jclepro.2020.120823
- He D, Teng X, Chen Y, Liu B, Wu J. Piston wind and energy saving based on the analysis of fresh air in the subway system. *Sustain Energy Technol Assess*. 2022;50(September 2021): 101805. doi:10.1016/j.seta.2021.101805
- Guan B, Liu X, Zhang T, Wang X. Hourly energy consumption characteristics of metro rail transit: train traction versus station operation. *Energy Built Environ*. 2023;4(January): 568-575. doi:10.1016/j.enbenv.2022.05.001
- González-Gil A, Palacin R, Batty P, Powell JP. A systems approach to reduce urban rail energy consumption. *Energy Convers Manage*. 2014;80:509-524. doi:10.1016/j.enconman.2014.01.060
- Powell JP, González-Gil A, Palacin R. Experimental assessment of the energy consumption of urban rail vehicles during stabling hours: influence of ambient temperature. *Appl Therm Eng*. 2014;66(1-2):541-547. doi:10.1016/j.applthermaleng.2014.02.057
- Falvo MC, Lamedica R, Bartoni R, Maranzano G. Energy management in metro-transit systems: an innovative proposal toward an integrated and sustainable urban mobility system including plug-in electric vehicles. *Electr Power Syst Res*. 2011;81(12):2127-2138. doi:10.1016/j.epsr.2011.08.004
- Tian Z, Weston P, Zhao N, Hillmansen S, Roberts C, Chen L. System energy optimisation strategies for metros with regeneration. *Transp Res Part C*. 2017;75:120-135. doi:10.1016/j.trc.2016.12.004
- Ahmadi S, Dastfan A, Assili M. Energy saving in metro systems: simultaneous optimization of stationary energy storage systems and speed profiles. *J Rail Transp Plan Manage*. 2018;8(1):78-90. doi:10.1016/j.jrtpm.2018.03.003
- Feng X, Mao B, Feng X, Feng J. Study on the maximum operation speeds of metro trains for energy saving as well as transport efficiency improvement. *Energy*. 2011;36(11): 6577-6582. doi:10.1016/j.energy.2011.09.004
- Pan D, Zhao L, Luo Q, Zhang C, Chen Z. Study on the performance improvement of urban rail transit system. *Energy*. 2018;161:1154-1171. doi:10.1016/j.energy.2018.07.067
- Zarkadoula M, Giannakopoulou K, Goumas G, et al. Energy audit in Athens metro stations for identifying energy consumption profiles of stationary loads. *Int J Sustain Energy*. 2022;41(8):1142-1163. doi:10.1080/14786451.2022.2028787
- Guan B, Liu X, Zhang T, Xia J. Energy consumption of subway stations in China: data and influencing factors. *Sustain Cities Soc*. 2018;43:451-461. doi:10.1016/j.scs.2018.09.018
- Lin L, Liu X, Zhang T, Liu X. Energy consumption index and evaluation method of public traffic buildings in China. *Sustain Cities Soc*. 2020;57(March):102132. doi:10.1016/j.scs.2020.102132
- Ahn J, Cho S, Chung DH. Development of a statistical analysis model to benchmark the energy use intensity of subway stations. *Appl Energy*. 2016;179:488-496. doi:10.1016/j.apenergy.2016.06.065
- Casals M, Gangoles M, Forcada N, Macarulla M, Giretti A. A breakdown of energy consumption in an underground station. *Energy Build*. 2014;78:89-97. doi:10.1016/j.enbuild.2014.04.020
- Yin H, Yang C, Yi L, et al. Ventilation and air conditioning system of deep-buried subway station in sub-tropical climates: energy-saving strategies. *Appl Therm Eng*. 2020;178(November 2019):115555. doi:10.1016/j.applthermaleng.2020.115555
- Wang J, Ghanem A, Rakha H, Du J. A rail transit simulation system for multi-modal energy-efficient routing applications. *Int J Sustain Transp*. 2021;15(3):187-202. doi:10.1080/15568318.2020.1718809
- Tang Z, Yin H, Yang C, Yu J, Guo H. Predicting the electricity consumption of urban rail transit based on binary nonlinear fitting regression and support vector regression. *Sustain Cities Soc*. 2021;66(2):102690. doi:10.1016/j.scs.2020.102690
- Yu Y, You S, Zhang H, Ye T, Wang Y, Wei S. A review on available energy saving strategies for heating, ventilation and air conditioning in underground metro stations. *Renew*

- Sustain Energy Rev.* 2021;141(February):110788. doi:10.1016/j.rser.2021.110788
29. Yu Y, You S, Zhang H, et al. Measuring and modeling moisture environment in underground metro stations during commissioning stage: a case study. *Build Serv Eng Res Technol.* 2022;43(2):241-259. doi:10.1177/01436244211038863
  30. Casals M, Gangoellets M, Forcada N, Macarulla M. Reducing lighting electricity use in underground metro stations. *Energy Convers Manage.* 2016;119:130-141. doi:10.1016/j.enconman.2016.04.034
  31. González-Gil A, Palacin R, Batty P. Optimal energy management of urban rail systems: key performance indicators. *Energy Convers Manage.* 2015;90:282-291. doi:10.1016/j.enconman.2014.11.035
  32. Li Y, He Q, Luo X, Zhang Y, Dong L. Calculation of life-cycle greenhouse gas emissions of urban rail transit systems: a case study of Shanghai Metro. *Resour Conserv Recy.* 2018;128:451-457. doi:10.1016/j.resconrec.2016.03.007
  33. Yuan W, Frey HC. Potential for metro rail energy savings and emissions reduction via eco-driving. *Appl Energy.* 2020;268(April):114944. doi:10.1016/j.apenergy.2020.114944
  34. Anderson R, Maxwell R, Harris NG. *Maximising the Potential for Metros to Reduce Energy Consumption and Deliver Low-Carbon Transportation in Cities*, CoMET and Nova Groups/Imperial College London. 2009.
  35. Del Pero F, Delogu M, Pierini M, Bonaffini D. Life cycle assessment of a heavy metro train. *J Clean Prod.* 2015;87(1):787-799. doi:10.1016/j.jclepro.2014.10.023
  36. To WM, Lee PKC, Yu BTW. Sustainability assessment of an urban rail system—the case of Hong Kong. *J Clean Prod.* 2020;253:119961. doi:10.1016/j.jclepro.2020.119961
  37. Song H. *Research on Evaluation of Urban Rail Transit Efficiency*, Master's thesis, Beijing Jiaotong University. 2015.
  38. Liu S, Wang H, Xing Y, Chen S. Energy consumption quota standard for urban rail transit stations with case studies. *J Transp Syst Eng Inf Technol.* 2020;20(4):231-235.
  39. Hong W, Kim S. A study on the energy consumption unit of subway stations in Korea. *Build Environ.* 2004;39(12):1497-1503. doi:10.1016/j.buildenv.2004.04.008
  40. Su Z, Li X. Energy benchmarking analysis of subway station with platform screen door system in China. *Tunn Undergr Space Technol.* 2022;128(July):104655. doi:10.1016/j.tust.2022.104655
  41. Yu Y, You S, Wei S, et al. Exploring the applicability of building energy performance certification systems in underground stations in China. *Sustainability.* 2022;14(6):3612. doi:10.3390/su14063612
  42. Dong D, Duan H, Mao R, et al. Towards a low carbon transition of urban public transport in megacities: A case study of Shenzhen, China. *Resour Conserv Recy.* 2018;134(Sep-September 2017):149-155. doi:10.1016/j.resconrec.2018.03.011
  43. Kumar GMS, Cao S. Simulation-based techno-economic feasibility study on sector coupled net-zero/positive energy metro railway system in Hong Kong. *Energy Convers Manage.* 2021;248(September):114786. doi:10.1016/j.enconman.2021.114786
  44. Lederer J, Ott C, Brunner PH, Ossberger M. The life cycle energy demand and greenhouse gas emissions of high-capacity urban transport systems: a case study from Vienna's subway line U2. *Int J Sustain Transp.* 2016;10(2):120-130. doi:10.1080/15568318.2013.869704
  45. Andrade CES, D'Agosto MA. Energy use and carbon dioxide emissions assessment in the lifecycle of passenger rail systems: the case of the Rio de Janeiro Metro. *J Clean Prod.* 2016;126:526-536. doi:10.1016/j.jclepro.2016.03.094
  46. Qiu L. Analysis of passenger flow characteristics in suburban section of passenger flow characteristics of urban rail transit (in Chinese). *Tianjin Constr Sci Technol.* 2020;30(03):74-77.
  47. Yu Y, Cheng J, You S, et al. Effect of implementing building energy efficiency labeling in China: a case study in Shanghai. *Energy Policy.* 2019;133(December 2018):110898. doi:10.1016/j.enpol.2019.110898
  48. Spearman C. The proof and measurement of association between two things. *Am J Psychol.* 1904;15(1):72-101. doi:10.2307/1412159
  49. Eb CDM. *Baseline Emission Factors of China's Regional Power Grids for Emission Reduction Projects in 2019*. Eb CDM; 2020: 1-3. <http://mee.gov.cn/ywgz/ydqhbh/wsqtzk/202012/W020201229610353340851.pdf>
  50. Chang B, Kendall A. Life cycle greenhouse gas assessment of infrastructure construction for California's high-speed rail system. *Transp Res Part D.* 2011;16(6):429-434. doi:10.1016/j.trd.2011.04.004
  51. Doll CNH, Balaban O. A methodology for evaluating environmental co-benefits in the transport sector: application to the Delhi metro. *J Clean Prod.* 2013;58:61-73. doi:10.1016/j.jclepro.2013.07.006

**How to cite this article:** Yu Y, You S, Ye T, et al. Characteristics and assessment of the electricity consumption of metro systems: a case study of Tianjin, China. *Energy Sci Eng.* 2023;1-13. doi:10.1002/ese3.1606